



# AC '97 SoundMAX<sup>®</sup> Codec

## AD1881

### AC '97 2.1 FEATURES

- Variable Sample Rate
- True Line-Level Output

### AC '97 FEATURES

- Fully Compliant AC '97 Analog I/O Component
- 48-Lead LQFP Package
- Multibit  $\Sigma\Delta$  Converter Architecture for Improved S/N Ratio greater than 90 dB
- 16-Bit Stereo Full-Duplex Codec
- Four Analog Line-Level Stereo Inputs for Connection from LINE, CD, VIDEO and AUX
- Two Analog Line-Level Mono Inputs for Speakerphone and PC BEEP
- Mono MIC Input Switchable from Two External Sources
- High Quality CD Input with Ground Sense
- Stereo Line-Level Output
- Mono Output for Speakerphone or Internal Speaker
- Power Management Support

### ENHANCED FEATURES

- Mobile Low Power Mixer Mode
- Digital Audio Mixer Mode
- DSP 16-Bit Serial Port Format, Slot 16 Mode
- Supports All Required WHQL Sample Rates
- Full Duplex Variable 7 kHz to 48 kHz Sampling Rate with 1 Hz Resolution
- Phat<sup>™</sup> Stereo 3D Stereo Enhancement
- Split Power Supplies (3.3 V Digital/5 V Analog)
- Extended 6-Bit Master Volume Control
- Audio Amp Power-Down Signal

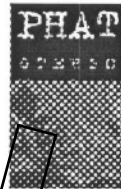

### FUNCTIONAL BLOCK DIAGRAM

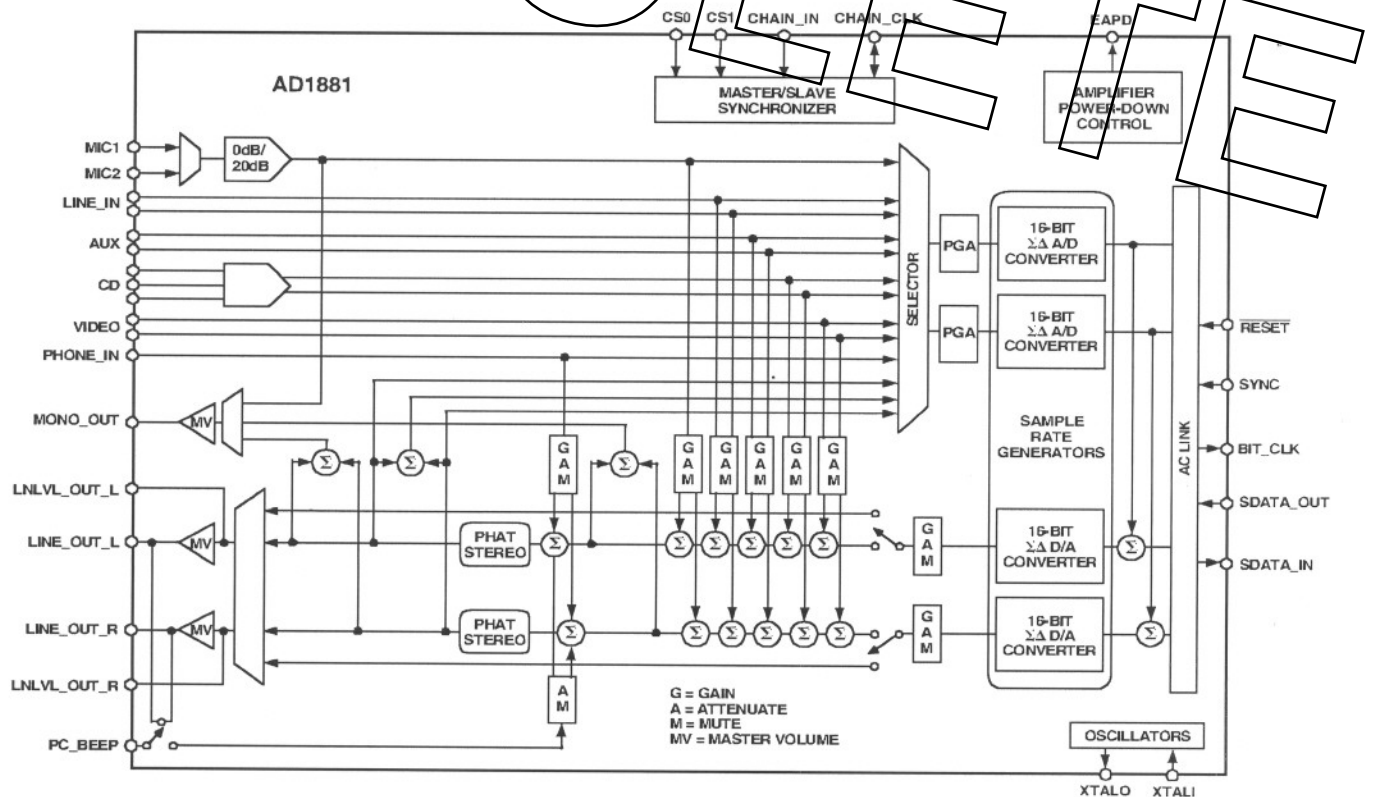

SoundMAX is a registered trademark and PHAT is a trademark of Analog Device, Inc.

REV. 0

Information furnished by Analog Devices is believed to be accurate and reliable. However, no responsibility is assumed by Analog Devices for its use, nor for any infringements of patents or other rights of third parties which may result from its use. No license is granted by implication or otherwise under any patent or patent rights of Analog Devices.

One Technology Way, P.O. Box 9106, Norwood, MA 02062-9106, U.S.A.  
 Tel: 781/329-4700 World Wide Web Site: <http://www.analog.com>  
 Fax: 781/326-8703 © Analog Devices, Inc., 1999

# AD1881—SPECIFICATIONS

## STANDARD TEST CONDITIONS UNLESS OTHERWISE NOTED

Temperature	25	°C	<i>DAC Test Conditions</i>
Digital Supply (V <sub>DD</sub> )	3.3/5.0	V	Calibrated
Analog Supply (V <sub>CC</sub> )	5.0	V	-3 dB Attenuation Relative to Full-Scale
Sample Rate (F <sub>s</sub> )	48	kHz	Input 0 dB
Input Signal	1008	Hz	10 kΩ Output Load
			<i>ADC Test Conditions</i>
			Calibrated
			0 dB Gain
			Input -3.0 dB Relative to Full-Scale

### ANALOG INPUT

Parameter	Min	Typ	Max	Units
Input Voltage (RMS Values Assume Sine Wave Input) LINE_IN, AUX, CD, VIDEO, PHONE_IN, PC_BEEP		1		V rms
		2.83		V p-p
MIC with +20 dB Gain (M20 = 1)		0.1		V rms
		0.283		V p-p
MIC with 0 dB Gain (M20 = 0)		1		V rms
		2.83		V p-p
Input Impedance*		20		kΩ
Input Capacitance*		5	7.5	pF

### MASTER VOLUME

Parameter	Min	Typ	Max	Units
Step Size (0 dB to -94.5 dB); LINE_OUT_L, LINE_OUT_R		1.5		dB
Output Attenuation Range Span*		-94.5		dB
Step Size (0 dB to -46.5 dB); MONO_OUT		1.5		dB
Output Attenuation Range Span*		-46.5		dB
Mute Attenuation of 0 dB Fundamental*			80	dB

### PROGRAMMABLE GAIN AMPLIFIER—ADC

Parameter	Min	Typ	Max	Units
Step Size (0 dB to 22.5 dB)		1.5		dB
PGA Gain Range Span		22.5		dB

### ANALOG MIXER—INPUT GAIN/AMPLIFIERS/ATTENUATORS

Parameter	Min	Typ	Max	Units
Signal-to-Noise Ratio (SNR) CD to LINE_OUT	90			dB
Other to LINE_OUT		90		dB
Step Size (+12 dB to -34.5 dB): (All Steps Tested) MIC, LINE_IN, AUX, CD, VIDEO, PHONE_IN, DAC		1.5		dB
Input Gain/Attenuation Range: MIC, LINE, AUX, CD, VIDEO, PHONE_IN, DAC		46.5		dB
Step Size (0 dB to -45 dB): (All Steps Tested) PC_BEEP		3.0		dB
Input Gain/Attenuation Range: PC_BEEP		45		dB

\*Guaranteed, not tested.  
Specifications subject to change without notice.

**AD1881**

**DIGITAL DECIMATION AND INTERPOLATION FILTERS\***

Parameter	Min	Typ	Max	Units
Passband	0		$0.4 \times F_S$	Hz
Passband Ripple			$\pm 0.09$	dB
Transition Band	$0.4 \times F_S$		$0.6 \times F_S$	Hz
Stopband	$0.6 \times F_S$		$\infty$	Hz
Stopband Rejection	-74			dB
Group Delay			$12/F_S$	sec
Group Delay Variation Over Passband			0.0	$\mu$ s

**ANALOG-TO-DIGITAL CONVERTERS**

Parameter	Min	Typ	Max	Units
Resolution		16		Bits
Total Harmonic Distortion (THD)			0.02	%
Dynamic Range (-60 dB Input THD+N Referenced to Full Scale, A-Weighted)	85	87	-74	dB
Signal-to-Intermodulation Distortion* (CCIF Method)		85		dB
ADC Crosstalk*				
Line Inputs (Input L, Ground R, Read R, Input R, Ground L, Read L)		-100	-90	dB
LINE_IN to Other		-90	-85	dB
Gain Error (Full-Scale Span Relative to Nominal Input Voltage)			$\pm 10$	%
Interchannel Gain Mismatch (Difference of Gain Errors)			$\pm 0.5$	dB
ADC Offset Error			$\pm 5$	mV

**DIGITAL-TO-ANALOG CONVERTERS**

Parameter	Min	Typ	Max	Units
Resolution		16		Bits
Total Harmonic Distortion (THD) LINE_OUT, LNLVL_OUT			0.02	%
Dynamic Range (-60 dB Input THD+N Referenced to Full Scale, A-Weighted)	85	90	-74	dB
Signal-to-Intermodulation Distortion* (CCIF Method)		85		dB
Gain Error (Full-Scale Span Relative to Nominal Input Voltage)			$\pm 10$	%
Interchannel Gain Mismatch (Difference of Gain Errors)			$\pm 0.5$	dB
DAC Crosstalk* (Input L, Zero R, Measure R_OUT; Input R, Zero L, Measure L_OUT)			-80	dB
Total Audible Out-of-Band Energy (Measured from $0.6 \times F_S$ to 20 kHz)*		-40		dB

**ANALOG OUTPUT**

Parameter	Min	Typ	Max	Units
Full-Scale Output Voltage (LINE_OUT, LNLVL_OUT)		1		V rms
Output Impedance*		2.83		V p-p
External Load Impedance*	10		500	$\Omega$
Output Capacitance*		15		k $\Omega$
External Load Capacitance			100	pF
V <sub>REF</sub>	2.0	2.2	2.4	pF
V <sub>REF_OUT</sub>		2.2		V
V <sub>REF_OUT</sub> Current Drive			5	V
Mute Click (Muted Output Minus Unmuted Midscale DAC Output)		$\pm 5$		mA
				mV

\*Guaranteed, not tested.  
Specifications subject to change without notice.

# AD1881

## STATIC DIGITAL SPECIFICATIONS

Parameter	Min	Typ	Max	Units
High Level Input Voltage ( $V_{IH}$ ): Digital Inputs	$0.65 \times DV_{DD}$			V
Low Level Input Voltage ( $V_{IL}$ )			$0.35 \times DV_{DD}$	V
High Level Output Voltage ( $V_{OH}$ ), $I_{OH} = -0.5$ mA	$0.9 \times DV_{DD}$			V
Low Level Output Voltage ( $V_{OL}$ ), $I_{OL} = +0.5$ mA			$0.1 \times DV_{DD}$	V
Input Leakage Current	-10		10	$\mu$ A
Output Leakage Current	-10		10	$\mu$ A

## POWER SUPPLY

Parameter	Min	Typ	Max	Units
Power Supply Range – Analog	4.75		5.25	V
Power Supply Range – Digital (5/3.3 V)	4.75/3.0		5.25/3.6	V
Power Dissipation – 5 V / 5 V		520		mW
Power Dissipation – 5 V / 3.3 V		330		mW
Analog Supply Current – 5 V		40		mA
Digital Supply Current – 5 V		63		mA
Digital Supply Current – 3.3 V		40		mA
Power Supply Rejection (100 mV p-p Signal @ 1 kHz)* (At Both Analog and Digital Supply Pins, Both ADCs and DACs)		40		dB

## CLOCK SPECIFICATIONS\*

Parameter	Min	Typ	Max	Units
Input Clock Frequency		24.576		MHz
Recommended Clock Duty Cycle	45	50	55	%

## POWER-DOWN MODE

Parameter	Set Bits	$DV_{DD}$ (3.3 V)		$AV_{DD}$ (5 V)		Units
		Typ		Typ		
ADC	PR0	31		26		mA
DAC	PR1	31		24		mA
ADC and DAC	PR1, PR0	6		18		mA
ADC + DAC + Mixer (Analog CD On)	LPMIX, PR1, PR0	6		10		mA
Mixer	PR2	35		16		mA
ADC + Mixer	PR2, PR0	31		10		mA
DAC + Mixer	PR2, PR1	31		8		mA
ADC + DAC + Mixer	PR2, PR1, PR0	6		2		mA
Analog CD Only (AC-Link On)	LPMIX, PR5, PR1, PR0	6		10		mA
Analog CD Only (AC-Link Off)	LPMIX, PR1, PR0	0		10		mA
Standby	PR5, PR4, P43, PR2, PR1, PR0	0		0.13		mA

\*Guaranteed, not tested.

Specifications subject to change without notice.

AD1881

**TIMING PARAMETERS (GUARANTEED OVER OPERATING TEMPERATURE RANGE)**

Parameter	Symbol	Min	Typ	Max	Units
RESET Active Low Pulsewidth	tRST_LOW	50			ns
RESET Inactive to BIT_CLK Startup Delay	tRST2CLK		833		µs
SYNC Active High Pulsewidth	tSYNC_HIGH	80			ns
SYNC Low Pulsewidth	tSYNC_LOW		19.5		µs
SYNC Inactive to BIT_CLK Startup Delay	tSYNC2CLK	162.8			ns
BIT_CLK Frequency			12.288		MHz
BIT_CLK Period	tCLK_PERIOD		81.4		ns
BIT_CLK Output Jitter <sup>1</sup>				750	ps
BIT_CLK High Pulsewidth	tCLK_HIGH	36.62	40.69	44.76	ns
BIT_CLK Low Pulsewidth	tCLK_LOW	36.62	40.69	44.76	ns
SYNC Frequency			48.0		kHz
SYNC Period	tSYNC_PERIOD		20.8		µs
Setup to Falling Edge of BIT_CLK	tSETUP	5			ns
Hold from Falling Edge of BIT_CLK	tHOLD	5			ns
BIT_CLK Rise Time	tRISECLK	2	4	10	ns
BIT_CLK Fall Time	tFALLCLK	2	4	10	ns
SYNC Rise Time	tRISESYNC	2	4	10	ns
SYNC Fall Time	tFALLSYNC	2	4	10	ns
SDATA_IN Rise Time	tRISEDIN	2	4	10	ns
SDATA_IN Fall Time	tFALLDIN	2	4	10	ns
SDATA_OUT Rise Time	tRISEOUT	2	4	10	ns
SDATA_OUT Fall Time	tFALLOUT	2	4	10	ns
End of Slot 2 to BIT_CLK, SDATA_IN Low	tS2_PDWN	0		10	ms
Setup to Trailing Edge of RESET (Applies to SYNC, SDATA_OUT)	tSETUP2RST	15			ns
Rising Edge of RESET to HI-Z Delay (ATE Test Mode)	tOFF			25	ns
Propagation Delay				15	ns

NOTES

<sup>1</sup>Output jitter is directly dependent on crystal input jitter.  
 Specifications subject to change without notice.

# AD1881

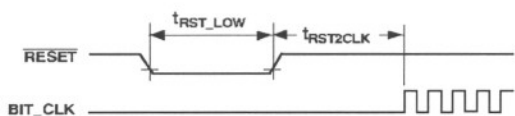

Figure 1. Cold Reset

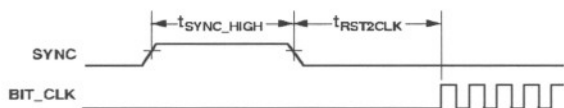

Figure 2. Warm Reset

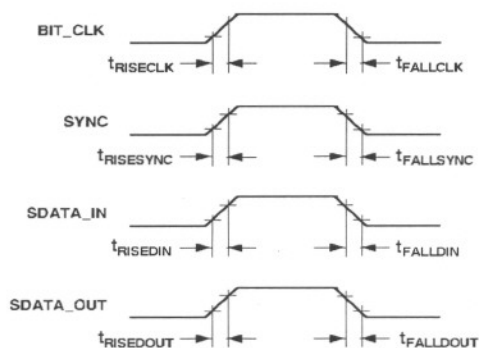

Figure 5. Signal Rise and Fall Time

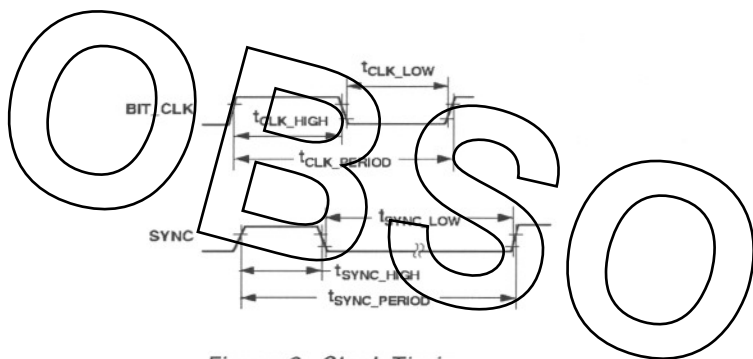

Figure 3. Clock Timing

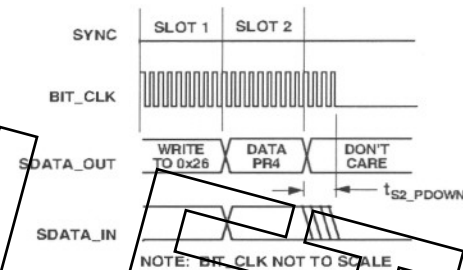

Figure 6. AC Link Low Power Mode Timing

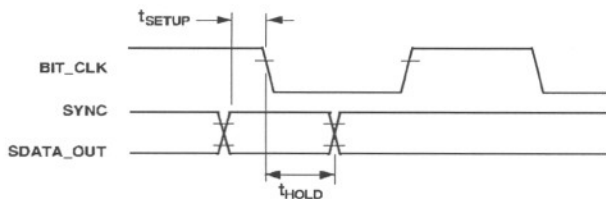

Figure 4. Data Setup and Hold

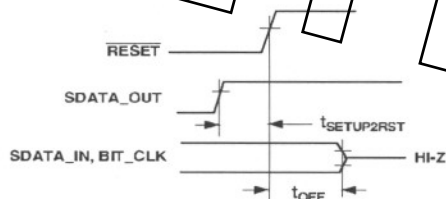

Figure 7. ATE Test Mode

# AD1881

## ABSOLUTE MAXIMUM RATINGS\*

Parameter	Min	Max	Units
Power Supplies			
Digital ( $V_{DD}$ )	-0.3	6.0	V
Analog ( $V_{CC}$ )	-0.3	6.0	V
Input Current (Except Supply Pins)		$\pm 10.0$	mA
Analog Input Voltage (Signal Pins)	-0.3	$V_{CC} + 0.3$	V
Digital Input Voltage (Signal Pins)	-0.3	$V_{DD} + 0.3$	V
Ambient Temperature (Operating)	0	+70	$^{\circ}C$
Storage Temperature	-65	+150	$^{\circ}C$

\*Stresses greater than those listed under Absolute Maximum Ratings may cause permanent damage to the device. This is a stress rating only; functional operation of the device at these or any other conditions above those indicated in the operational section of this specification is not implied. Exposure to absolute maximum rating conditions for extended periods may affect device reliability.

## ORDERING GUIDE

Model	Temperature Range	Package Description	Package Option*
AD1881JST	0 $^{\circ}C$ to +70 $^{\circ}C$	48-Lead LQFP	ST-48

\*ST = Thin Quad Flatpack.

## ENVIRONMENTAL CONDITIONS

Ambient Temperature Rating

$$T_{AMB} = T_{CASE} - (P_D \times \theta_{CA})$$

$$T_{CASE} = \text{Case Temperature in } ^{\circ}C$$

$$P_D = \text{Power Dissipation in W}$$

$$\theta_{CA} = \text{Thermal Resistance (Case-to-Ambient)}$$

$$\theta_{JA} = \text{Thermal Resistance (Junction-to-Ambient)}$$

$$\theta_{JC} = \text{Thermal Resistance (Junction-to-Case)}$$

Package	$\theta_{JA}$	$\theta_{JC}$	$\theta_{CA}$
LQFP	76.2 $^{\circ}C/W$	17 $^{\circ}C/W$	59.2 $^{\circ}C/W$

OBSOLETE

## CAUTION

ESD (electrostatic discharge) sensitive device. Electrostatic charges as high as 4000 V readily accumulate on the human body and test equipment and can discharge without detection. Although the AD1881 features proprietary ESD protection circuitry, permanent damage may occur on devices subjected to high energy electrostatic discharges. Therefore, proper ESD precautions are recommended to avoid performance degradation or loss of functionality.



## PIN CONFIGURATION 48-Lead LQFP

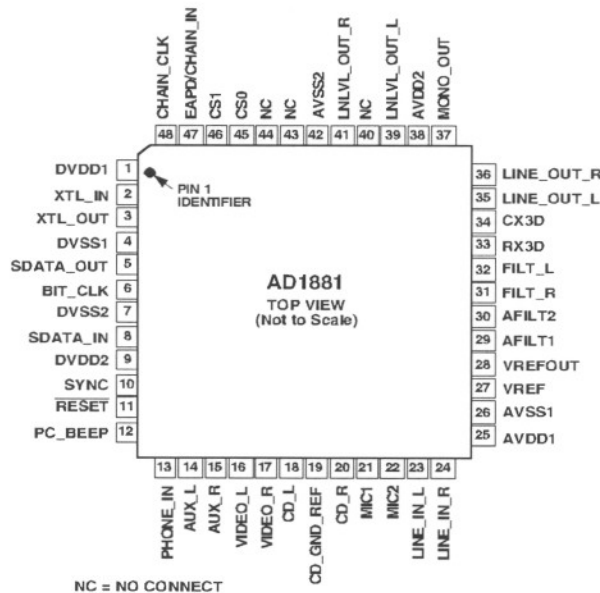

## AD1881

## PIN FUNCTION DESCRIPTIONS

## Digital I/O

Pin Name	LQFP	I/O	Description
XTL_IN	2	I	Crystal (or Clock) Input, 24.576 MHz.
XTL_OUT	3	O	Crystal Output.
SDATA_OUT	5	I	AC-Link Serial Data Output, AD1881 Input Stream.
BIT_CLK	6	O/I*	AC-Link Bit Clock. 12.288 MHz Serial Data Clock. Daisy Chain Output Clock.
SDATA_IN	8	O	AC-Link Serial Data Input. AD1881 Output Stream.
SYNC	10	I	AC-Link Frame Sample Sync 48 kHz Fixed Rate.
RESET	11	I	AC-Link Reset. AD1881 Master H/W Reset.

\*Input if configured as a slave device.

## Daisy Chain Connections

Pin Name	LQFP	Type	Description
CS0	45	I	Daisy Chain Codec Select LSB, ADC/DAC Right Bit Streams.
CS1	46	I	Daisy Chain Codec Select MSB, ADC/DAC Left Bit Streams.
EAPD	47	O	External Amp Power-Down Control Signal, Default LO, Active HI
CHAIN_IN	47	I	Daisy Chain Data Input for Data from Slave Codecs SDATA_IN.
CHAIN_CLK	48	I/O	24.576 MHz Buffered Clock Input/Output for Slave Codecs.

## Analog I/O

These signals connect the AD1881 component to analog sources and sinks, including microphones and speakers.

Pin Name	LQFP	I/O	Description
PC_BEEP	12	I	PC BEEP. PC Speaker BEEP Passthrough.
PHONE_IN	13	I	Phone. From Telephony Subsystem Speakerphone or Handset.
AUX_L	14	I	Auxiliary Input Left Channel.
AUX_R	15	I	Auxiliary Input Right Channel.
VIDEO_L	16	I	Video Audio Left Channel.
VIDEO_R	17	I	Video Audio Right Channel.
CD_L	18	I	CD Audio Left Channel.
CD_GND_REF	19	I	CD Audio Analog Ground Reference for Differential CD Input.
CD_R	20	I	CD Audio Right Channel.
MIC1	21	I	Microphone 1. Desktop Microphone Input.
MIC2	22	I	Microphone 2. Second Microphone Input.
LINE_IN_L	23	I	Line In Left Channel.
LINE_IN_R	24	I	Line In Right Channel.
LINE_OUT_L	35	O	Line Out Left Channel.
LINE_OUT_R	36	O	Line Out Right Channel.
MONO_OUT	37	O	Monaural Output to Telephony Subsystem Speakerphone.
LNLVL_OUT_L	39	O	Line-Level Output Left Channel.
LNLVL_OUT_R	41	O	Line-Level Output Right Channel.

## Filter/Reference

These signals are connected to resistors, capacitors, or specific voltages.

Pin Name	LQFP	I/O	Description
VREF	27	O	Voltage Reference Filter.
VREFOUT	28	O	Voltage Reference Output 5 mA Drive (Intended for MIC Bias).
AFILT1	29	O	Antialiasing Filter Capacitor—ADC Right Channel.
AFILT2	30	O	Antialiasing Filter Capacitor—ADC Left Channel.
FILT_R	31	O	AC-Coupling Filter Capacitor—ADC Right Channel.
FILT_L	32	O	AC-Coupling Filter Capacitor—ADC Left Channel.
RX3D	33	O	3D Phat Stereo Enhancement—Capacitor.
CX3D	34	I	3D Phat Stereo Enhancement—Capacitor.



**AD1881**

**Power and Ground Signals**

Pin Name	LQFP	Type	Description
DV <sub>DD1</sub>	1	I	Digital V <sub>DD</sub> -5.0 V/3.3 V
DV <sub>SS1</sub>	4	I	Digital GND
DV <sub>SS2</sub>	7	I	Digital GND
DV <sub>DD2</sub>	9	I	Digital V <sub>DD</sub> -5.0 V/3.3 V
AV <sub>DD1</sub>	25	I	Analog V <sub>DD</sub> -5.0 V
AV <sub>SS1</sub>	26	I	Analog GND
AV <sub>DD2</sub>	38	I	Analog V <sub>DD</sub> -5.0 V
AV <sub>SS2</sub>	42	I	Analog GND

**No Connects**

Pin Name	LQFP	Type	Description
NC	40		No Connect
NC	43		No Connect
NC	44		No Connect

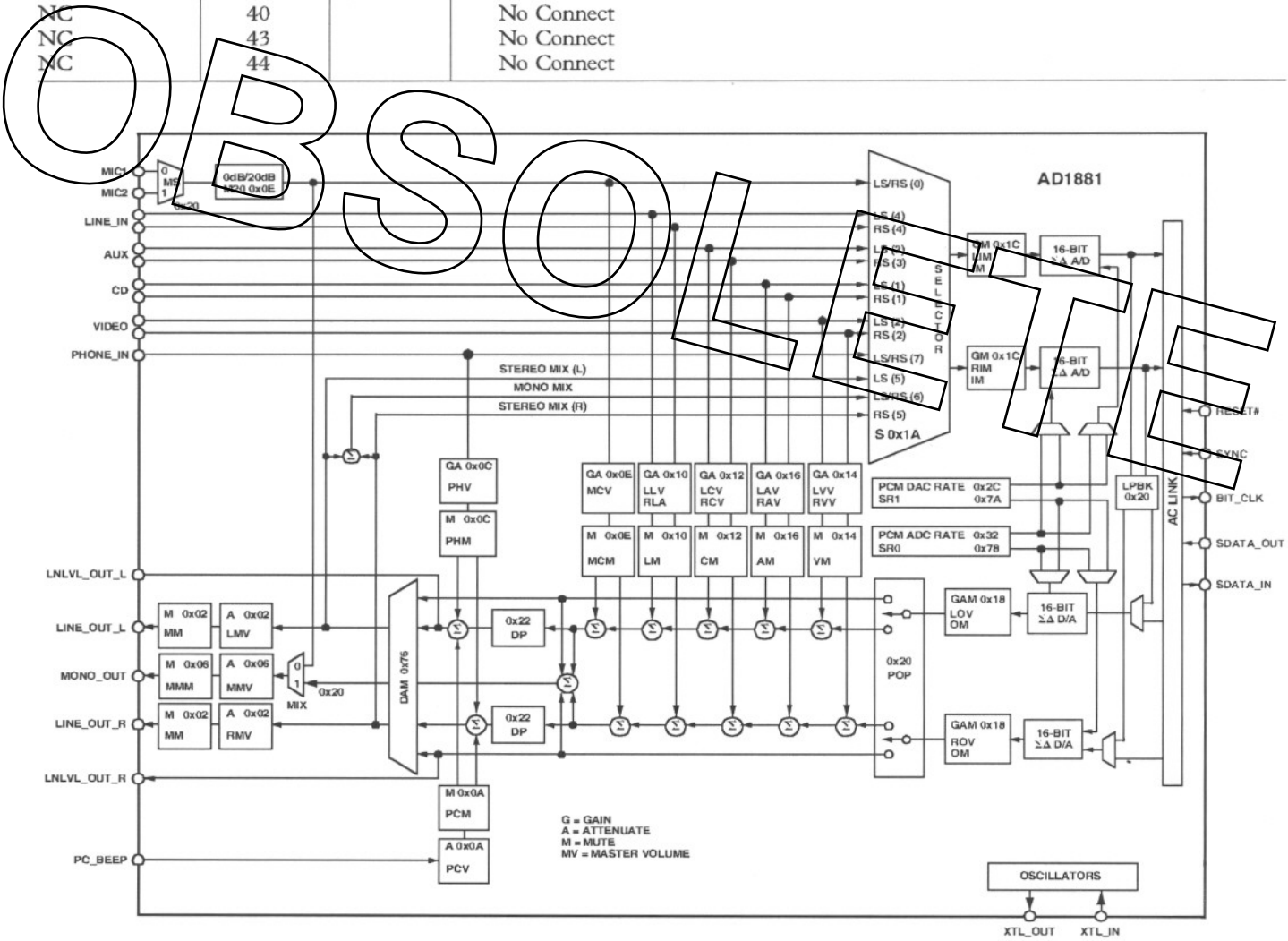

Figure 8. Block Diagram Register Map

LPBK available in test mode only. (Needs modification)

# AD1881

## PRODUCT OVERVIEW

The AD1881 is the first audio Codec to meet the *Audio Codec '97 2.0 and 2.1 Extensions*. In addition, the AD1881 SoundMAX Codec is designed to meet all requirements of the *Audio Codec '97, Component Specification*, Revision 1.03, © 1996, Intel Corporation, found at [www.Intel.com](http://www.Intel.com). The AD1881 also includes some other Codec enhanced features such as communicating to three Codecs on the same link, a DSP serial port mode, modem sample rates and filtering, and built-in Phat Stereo 3D enhancement.

The AD1881 is an analog front end for high performance PC audio, modem, or DSP applications. The AC '97 architecture defines a 2-chip audio solution comprising a digital audio controller, plus a high quality analog component that includes Digital-to-Analog Converters (DACs), Analog-to-Digital Converters (ADCs), mixer and I/O.

The main architectural features of the AD1881 are the high quality analog mixer section, two channels of  $\Sigma\Delta$  ADC conversion, two channels of  $\Sigma\Delta$  DAC conversion and Data Direct Scrambling (D<sup>2</sup>S) rate generators. The AD1881's left channel ADC and DAC are compatible for modem applications supporting irrational sample rates and modem filtering requirements.

## FUNCTIONAL DESCRIPTION

This section overviews the functionality of the AD1881 and is intended as a general introduction to the capabilities of the device. Detailed reference information may be found in the descriptions of the Indexed Control Registers.

### Analog Inputs

The Codec contains a stereo pair of  $\Sigma\Delta$  ADCs. Inputs to the ADC may be selected from the following analog signals: telephony (PHONE\_IN), mono microphone (MIC1 or MIC2), stereo line (LINE\_IN), auxiliary line input (AUX), stereo CD ROM (CD), stereo audio from a video source (VIDEO) and post-mixed stereo or mono line output (LINE\_OUT).

### Analog Mixing

PHONE\_IN, MIC1 or MIC2, LINE\_IN, AUX, CD and VIDEO can be mixed in the analog domain with the stereo output from the DACs. Each channel of the stereo analog inputs may be independently gained or attenuated from +12 dB to -34.5 dB in 1.5 dB steps. The summing path for the mono inputs (PHONE\_IN, MIC1, and MIC2 to LINE\_OUT) duplicates mono channel data on both the left and right LINE\_OUT. Additionally, the PC attention signal (PC\_BEEP) may be mixed with the line output. A switch allows the output of the DACs to bypass the Phat Stereo 3D enhancement.

### Digital Audio Mode

The AD1881 is designed with a Digital Audio Mode (DAM) that allows mixing of all analog inputs independent of the DAC output signal path. Mixed analog input signals may be sent to the ADCs for processing by the controller or the host, and may be used during simultaneous capture and playback at different sample rates.

### Analog-to-Digital Signal Path

The selector sends left and right channel information to the programmable gain amplifier (PGA). The PGA following the selector allows independent gain control for each channel entering the ADC from 0 dB to +22.5 dB in 1.5 dB steps. Each channel of the ADC is independent, and can process left and right channel data at different sample rates.

### Sample Rates and D<sup>2</sup>S

The AD1881 default mode sets the Codec to operate at 48 kHz sample rates. The converter pairs may process left and right channel data at different sample rates. The AD1881 sample rate generator allows the Codec to instantaneously change and process sample rates from 7 kHz to 48 kHz with a resolution of 1 Hz. The in-band integrated noise and distortion artifacts introduced by rate conversions are below -90 dB. The AD1881 uses a 4-bit D/A structure and Data Directed Scrambling (D<sup>2</sup>S) to enhance noise immunity on motherboards and in PC enclosures, and to suppress idle tones below the device's quantization noise floor. The D<sup>2</sup>S process pushes noise and distortion artifacts caused by errors in the multibit DAC to frequencies beyond the auditory response of the human ear and then filters them.

### Digital-to-Analog Signal Path

The analog output of the DAC may be gained or attenuated from +12 dB to -34.5 dB in 1.5 dB steps, and summed with any of the analog input signals. The summed analog signal enters the Master Volume stage where each channel of the mixer output may be attenuated from 0 dB to -94.5 dB in 1.5 dB steps or muted.

### Line-Level Outputs

The AD1881 offers a true line-level output for notebook docking station and home theater applications. The line-level output does not change with master volume settings.

### Host-Based Echo Cancellation Support

The AD1881 supports time correlated I/O data format by presenting MIC data on the left channel of the ADC and the mono summation of left and right output on the right channel. The ADC is splittable; left and right ADC data can be sampled at different rates.

### Power Management Modes

The AD1881 is designed to meet ACPI power consumption requirements through flexible power management control of all internal resources.

**AD1881**

**Indexed Control Registers**

Reg Num	Name	D15	D14	D13	D12	D11	D10	D9	D8	D7	D6	D5	D4	D3	D2	D1	D0	Default
00h	Reset	X	SE4	SE3	SE2	SE1	SE0	ID9	ID8	ID7	ID6	ID5	ID4	ID3	ID2	ID1	ID0	0100h
02h	Master Volume	MM	X	LMV5	LMV4	LMV3	LMV2	LMV1	LMV0	X	X	RMV5	RMV4	RMV3	RMV2	RMV1	RMV0	8000h
04h	Reserved	X	X	X	X	X	X	X	X	X	X	X	X	X	X	X	X	X
06h	Master Volume Mono	MMM	X	X	X	X	X	X	X	X	X	X	MMV 4	MMV 2	MMV 2	MMV 1	MMV 0	8000h
08h	Reserved	X	X	X	X	X	X	X	X	X	X	X	X	X	X	X	X	X
0Ah	PC BEEP Volume	PCM	X	X	X	X	X	X	X	X	X	X	PCV3	PCV2	PCV1	PCV0	X	8000h
0Ch	Phone In Volume	PHM	X	X	X	X	X	X	X	X	X	X	PHV4	PHV3	PHV2	PHV1	PHV0	8008h
0Eh	MIC Volume	MCM	X	X	X	X	X	X	X	X	M20	X	MCV4	MCV3	MCV2	MCV1	MCV0	8008h
10h	Line In Volume	LM	X	X	LLV4	LLV3	LLV2	LLV1	LLV0	X	X	X	RLV4	RLV3	RLV2	RLV1	RLV0	8808h
12h	CD Volume	CVM	X	X	LCV4	LCV3	LCV2	LCV1	LCV0	X	X	X	RCV4	RCV3	RCV2	RCV1	RCV0	8808h
14h	Video Volume	VM	X	X	LVV4	LVV3	LVV2	LVV1	LVV0	X	X	X	RVV4	RVV3	RVV2	RVV1	RVV0	8808h
16h	Aux Volume	AM	X	X	LAV4	LAV3	LAV2	LAV1	LAV0	X	X	X	RAV4	RAV3	RAV2	RAV1	RAV0	8808h
18h	PCM Out Vol	OM	X	X	LOV4	LOV3	LOV2	LOV1	LOV0	X	X	X	ROV4	ROV3	ROV2	ROV1	ROV0	8808h
1Ah	Record Select	X	X	X	X	X	LS2	LS1	LS0	X	X	X	X	X	RS2	RS1	RS0	0000h
1Ch	Record Gain	IM	X	X	X	LM3	LM2	LM1	LM0	X	X	X	X	RIM3	RIM2	RIM1	RIM0	8000h
1Eh	Reserved	X	X	X	X	X	X	X	X	X	X	X	X	X	X	X	X	X
20h	General Purpose	POP	X	3D	X	X	X	MIX	MS	LPEK	X	X	X	X	X	X	X	0000h
22h	3D Control	X	X	X	X	X	X	X	X	X	X	X	X	DP3	DP2	DP1	DP0	0000h
26h	Power-Down Cntrl/Stat	EAPD	X	PR5	PR4	PR3	PR2	PR1	PR0	X	X	X	X	RSE	ANL	DAC	ADC	000Xh
28h	Extended Audio ID	ID1	ID0	X	X	X	X	X	X	X	X	X	X	X	X	X	VRA	0001h
2Ah	Extended Audio Stat/Ctrl	X	X	X	X	X	X	X	X	X	X	X	X	X	X	X	VRA	0000h
2Ch/ (7Ah)*	PCM DAC Rate (SR1)	SR15	SR14	SR13	SR12	SR11	SR10	SR9	SR8	SR7	SR6	SR5	SR4	SR3	SR2	SR1	SR0	BB80h
32h / (78h)*	PCM ADC Rate (SR0)	SR15	SR14	SR13	SR12	SR11	SR10	SR9	SR8	SR7	SR6	SR5	SR4	SR3	SR2	SR1	SR0	BB80h
34h	Reserved	X	X	X	X	X	X	X	X	X	X	X	X	X	X	X	X	X
..	..	..	..	..	..	..	..	..	..	..	..	..	..	..	..	..	..	..
72h	Reserved	X	X	X	X	X	X	X	X	X	X	X	X	X	X	X	X	X
74h	Serial Configuration	SLOT 16	REG M2	REG M1	REG 0	DRQ EN	DLR Q2	DLR Q1	DLR Q0	X	X	X	X	X	DRRQ 2	DRRQ 1	DRRQ 0	7X0Xh
76h	Misc. Control Bits	DAC Z	LPMI X	X	DAM	DMS	DLSR	X	ALSR	MOD EN	SRX1 0D7	SRX8 D7	X	X	DRSR	X	ARSR	0404h
7Ch	Vendor ID1	F7	F6	F5	F4	F3	F2	F1	F0	S7	S6	S5	S4	S3	S2	S1	S0	4144h
7Eh	Vendor ID2	T7	T6	T5	T4	T3	T2	T1	T0	REV7	REV6	REV5	REV4	REV3	REV2	REV1	REV0	5340h

**NOTES**

All registers not shown and bits containing an X are assumed to be reserved.  
 Odd register addresses are aliased to the next lower even address.  
 Reserved registers should not be written.  
 Zeros should be written to reserved bits.  
 \*Indicates Aliased register for AD1819, AD1819A backward compatibility.

# AD1881

## Reset (Index 00h)

Reg Num	Name	D15	D14	D13	D12	D11	D10	D9	D8	D7	D6	D5	D4	D3	D2	D1	D0	Default
00h	Reset	X	SE4	SE3	SE2	SE1	SE0	ID9	ID8	ID7	ID6	ID5	ID4	ID3	ID2	ID1	ID0	0400h

Note: Writing any value to this register performs a register reset, which causes all registers to revert to their default values (except 74h, which forces the serial configuration). Reading this register returns the ID code of the part and a code for the type of 3D Stereo Enhancement.

ID[9:0] Identify Capability. The ID decodes the capabilities of AD1881 based on the following:

Bit = 1	Function	AD1881*
ID0	Dedicated MIC PCM In Channel	0
ID1	Modem Line Codec Support	0
ID2	Bass and Treble Control	0
ID3	Simulated Stereo (Mono to Stereo)	0
ID4	Headphone Out Support	1
ID5	Loudness (Bass Boost) Support	0
ID6	18-Bit DAC Resolution	0
ID7	20-Bit DAC Resolution	0
ID8	18-Bit ADC Resolution	0
ID9	20-Bit ADC Resolution	0

\*The AD1881 contains none of the optional features identified by these bits.

SE[4:0] Stereo Enhancement. The 3D stereo enhancement identifies the Analog Devices 3D stereo enhancement.

## Master Volume Registers (Index 02h)

Reg Num	Name	D15	D14	D13	D12	D11	D10	D9	D8	D7	D6	D5	D4	D3	D2	D1	D0	Default
02h	Master Volume	MM	X	LMV5	LMV4	LMV3	LMV2	LMV1	LMV0	X	X	RMV5	RMV4	RMV3	RMV2	RMV1	RMV0	8000h

RMV[5:0] Right Master Volume Control. The least significant bit represents 1.5 dB. This register controls the output from 0 dB to a maximum attenuation of -94.5 dB.

LMV[5:0] Left Master Volume Control. The least significant bit represents 1.5 dB. This register controls the output from 0 dB to a maximum attenuation of -94.5 dB.

MM Master Volume Mute. When this bit is set to "1," the channel is muted.

MM	xMV5 . . . xMV0	Function
0	00 0000	0 dB Attenuation
0	01 1111	-46.5 dB Attenuation
0	11 1111	-94.5 dB Attenuation
1	xx xxxx	-∞ dB Attenuation

## Master Volume Mono (Index 06h)

Reg Num	Name	D15	D14	D13	D12	D11	D10	D9	D8	D7	D6	D5	D4	D3	D2	D1	D0	Default
06h	Master Volume Mono	MMM	X	X	X	X	X	X	X	X	X	X	MMV4	MMV3	MMV2	MMV1	MMV0	8000h

MMV[4:0] Mono Master Volume Control. The least significant bit represents 1.5 dB. This register controls the output from 0 dB to a maximum attenuation of -46.5 dB.

MMM Mono Master Volume Mute. When this bit is set to "1," the channel is muted.

**AD1881**

**PC BEEP Register (Index 0Ah)**

Reg Num	Name	D15	D14	D13	D12	D11	D10	D9	D8	D7	D6	D5	D4	D3	D2	D1	D0	Default
0Ah	PC_BEEP Volume	PCM	X	X	X	X	X	X	X			X	PCV3	PCV2	PCV1	PCV0	X	8000h

**PCV[3:0]** PC BEEP Volume Control. The least significant bit represents 3 dB attenuation. This register controls the output from 0 dB to a maximum attenuation of -45 dB. The PC BEEP is routed to Left and Right Line outputs even when the RESET pin is asserted. This is so that Power on Self-Test (POST) codes can be heard by the user in case of a hardware problem with the PC.

**PCM** PC BEEP Mute. When this bit is set to "1," the channel is muted.

PCM	PCV3 . . . PCV0	Function
0	0000	0 dB Attenuation
0	1111	-45 dB Attenuation
1	xxxx	-∞ dB Attenuation

**Phone Volume (Index 0Ch)**

Reg Num	Name	D15	D14	D13	D12	D11	D10	D9	D8	D7	D6	D5	D4	D3	D2	D1	D0	Default
0Ch	Phone Volume	PHM	X	X	X	X	X	X	X			X	PHV4	PHV3	PHV2	PHV1	PHV0	8008h

**PHV[4:0]** Phone Volume. Allows setting the Phone Volume Attenuator in 32 steps. The LSB represents 1.5 dB, and the range is +12 dB to -34.5 dB. The default value is 0 dB, mute enabled.

**PHM** Phone Mute. When this bit is set to "1," the channel is muted.

**MIC Volume (Index 0Eh)**

Reg Num	Name	D15	D14	D13	D12	D11	D10	D9	D8	D7	D6	D5	D4	D3	D2	D1	D0	Default
0Eh	Mic Volume	MCM	X	X	X	X	X	X	X	X	M20	X	MCV4	MCV3	MCV2	MCV1	MCV0	8008h

**MCV[4:0]** MIC Volume Gain. Allows setting the MIC Volume attenuator in 32 steps. The LSB represents 1.5 dB, and the range is +12 dB to -34.5 dB. The default value is 0 dB, mute enabled.

**M20** Microphone 20 dB Gain Block  
 0 = Disabled; Gain = 0 dB.  
 1 = Enabled; Gain = 20 dB.

**MCM** MIC Mute. When this bit is set to "1," the channel is muted.

**Line In Volume (Index 10h)**

Reg Num	Name	D15	D14	D13	D12	D11	D10	D9	D8	D7	D6	D5	D4	D3	D2	D1	D0	Default
10h	Line InVolume	LM	X	X	LLV4	LLV3	LLV2	LLV1	LLV0	X	X	X	RLV4	RLV3	RLV2	RLV1	RLV0	8808h

**RLV[4:0]** Right Line In Volume. Allows setting the Line In right channel attenuator in 32 steps. The LSB represents 1.5 dB, and the range is +12 dB to -34.5 dB. The default value is 0 dB, mute enabled.

**LLV[4:0]** Line In Volume Left. Allows setting the Line In left channel attenuator in 32 steps. The LSB represents 1.5 dB, and the range is +12 dB to -34.5 dB. The default value is 0 dB, mute enabled.

**LM** Line In Mute. When this bit is set to "1," the channel is muted.

# AD1881

## CD Volume (Index 12h)

Reg Num	Name	D15	D14	D13	D12	D11	D10	D9	D8	D7	D6	D5	D4	D3	D2	D1	D0	Default
12h	CD Volume	CVM	X	X	LCV4	LCV3	LCV2	LCV1	LCV0	X	X	X	RCV4	RCV3	RCV2	RCV1	RCV0	8808h

RCV[4:0] Right CD Volume. Allows setting the CD right channel attenuator in 32 steps. The LSB represents 1.5 dB, and the range is +12 dB to -34.5 dB. The default value is 0 dB, mute enabled.

LCV[4:0] Left CD Volume. Allows setting the CD left channel attenuator in 32 steps. The LSB represents 1.5 dB, and the range is +12 dB to -34.5 dB. The default value is 0 dB, mute enabled.

CVM CD Volume Mute. When this bit is set to "1," the channel is muted.

## Video Volume (Index 14h)

Reg Num	Name	D15	D14	D13	D12	D11	D10	D9	D8	D7	D6	D5	D4	D3	D2	D1	D0	Default
14h	Video Volume	VM	X	X	LVV4	LVV3	LVV2	LVV1	LVV0	X	X	X	RVV4	RVV3	RVV2	RVV1	RVV0	8808h

RVV[4:0] Right Video Volume. Allows setting the Video right channel attenuator in 32 steps. The LSB represents 1.5 dB, and the range is +12 dB to -34.5 dB. The default value is 0 dB, mute enabled.

LVV[4:0] Left Video Volume. Allows setting the Video left channel attenuator in 32 steps. The LSB represents 1.5 dB, and the range is +12 dB to -34.5 dB. The default value is 0 dB, mute enabled.

VM Video Mute. When this bit is set to "1," the channel is muted.

## AUX Volume (Index 16h)

Reg Num	Name	D15	D14	D13	D12	D11	D10	D9	D8	D7	D6	D5	D4	D3	D2	D1	D0	Default
16h	Aux Volume	AM	X	X	LAV4	LAV3	LAV2	LAV1	LAV0	X	X	X	RAV4	RAV3	RAV2	RAV1	RAV0	8808h

RAV[4:0] Right Aux. Volume. Allows setting the Aux right channel attenuator in 32 steps. The LSB represents 1.5 dB, and the range is +12 dB to -34.5 dB. The default value is 0 dB, mute enabled.

LAV[4:0] Left Aux. Volume. Allows setting the Aux left channel attenuator in 32 steps. The LSB represents 1.5 dB, and the range is +12 dB to -34.5 dB. The default value is 0 dB, mute enabled.

AM Aux. Mute. When this bit is set to "1," the channel is muted.

## PCM Out Volume (Index 18h)

Reg Num	Name	D15	D14	D13	D12	D11	D10	D9	D8	D7	D6	D5	D4	D3	D2	D1	D0	Default
18h	PCM Out Volume	OM	X	X	LOV4	LOV3	LOV2	LOV1	LOV0	X	X	X	ROV4	ROV3	ROV2	ROV1	ROV0	8808h

ROV[4:0] Right PCM Out Volume. Allows setting the PCM right channel attenuator in 32 steps. The LSB represents 1.5 dB, and the range is +12 dB to -34.5 dB. The default value is 0 dB, mute enabled.

LOV[4:0] Left PCM Out Volume. Allows setting the PCM left channel attenuator in 32 steps. The LSB represents 1.5 dB, and the range is +12 dB to -34.5 dB. The default value is 0 dB, mute enabled.

OM PCM Out Volume Mute. When this bit is set to "1," the channel is muted.

Volume Table (Index 0Ch to 18h)

MM	x4 . . . x0	Function
0	00000	+12 dB Gain
0	01000	0 dB Gain
0	11111	-34.5 dB Gain
1	xxxxx	-∞ dB Gain

**AD1881**

**Record Select Control Register (Index 1Ah)**

Reg Num	Name	D15	D14	D13	D12	D11	D10	D9	D8	D7	D6	D5	D4	D3	D2	D1	D0	Default
1Ah	Record Select	X	X	X	X	X	LS2	LS1	LS0	X	X	X	X	X	RS2	RS1	RS0	0000h

RS[2:0] Right Record Select

LS[2:0] Left Record Select.

Used to select the record source independently for right and left. See table for legend.

The default value is 0000h, which corresponds to MIC in.

RS2 . . . RS0	Right Record Source
0	MIC
1	CD_R
2	VIDEO_R
3	AUX_R
4	LINE_IN_R
5	Stereo Mix (R)
6	Mono Mix
7	PHONE_IN

LS2 . . . LS0	Left Record Source
0	MIC
1	CD_L
2	VIDEO_L
3	AUX_L
4	LINE_IN_L
5	Stereo Mix (L)
6	Mono Mix
7	PHONE_IN

OBSOLETE

**Record Gain (Index 1Ch)**

Reg Num	Name	D15	D14	D13	D12	D11	D10	D9	D8	D7	D6	D5	D4	D3	D2	D1	D0	Default
1Ch	Record Gain	IM	X	X	X	LIM3	LIM2	LIM1	LIM0	X	X	X	X	RIM3	RIM2	RIM1	RIM0	8000h

RIM[3:0] Right Input Mixer Gain Control. Each LSB represents 1.5 dB, 0000 = 0 dB and the range is 0 dB to +22.5 dB.

LIM[3:0] Left Input Mixer Gain Control. Each LSB represents 1.5 dB, 0000 = 0 dB and the range is 0 dB to +22.5 dB.

IM Input Mute.  
 0 = Unmuted,  
 1 = Muted or -∞ dB gain.

IM	xIM3 . . . xIM0	Function
0	1111	+22.5 dB Gain
0	0000	0 dB Gain
1	xxxxx	-∞ dB Gain

# AD1881

## General Purpose Register (Index 20h)

Reg Num	Name	D15	D14	D13	D12	D11	D10	D9	D8	D7	D6	D5	D4	D3	D2	D1	D0	Default
20h	General Purpose	POP	X	3D	X	X	X	MIX	MS	LPBK	X	X	X	X	X	X	X	0000h

Note: This register should be read before writing to generate a mask for only the bit(s) that need to be changed. The function default value is 0000h which is all off.

LPBK Loopback Control. ADC/DAC Digital Loopback Mode

MS MIC Select  
0 = MIC1.  
1 = MIC2.

MIX Mono Output Select  
0 = Mix.  
1 = MIC.

3D 3D Phat Stereo Enhancement  
0 = Phat Stereo is off.  
1 = Phat Stereo is on.

POP PCM Output Path and Mute. The POP bit controls the optional PCM out 3D bypass path (the pre- and post-3D PCM out paths are mutually exclusive)  
0 = pre-3D.  
1 = post-3D.

## 3D Control Register (Index 22h)

Reg Num	Name	D15	D14	D13	D12	D11	D10	D9	D8	D7	D6	D5	D4	D3	D2	D1	D0	Default
22h*	3D Control	X	X	X	X	X	X	X	X	X	X	X	X	DP3	DP2	DP1	DP0	0000h

DP[2:0] Depth Control. Sets 3D "Depth" Phat Stereo enhancement according to table below.

DP3 . . . DP0	Depth
0000	0%
0001	6.67%
.	.
1110	93.33%
1111	100%



**AD1881**

**Subsection Ready Register (Index 26h)**

Reg Num	Name	D15	D14	D13	D12	D11	D10	D9	D8	D7	D6	D5	D4	D3	D2	D1	D0	Default
26h	Power-Down Cntrl/Stat	EAPD	X	PR5	PR4	PR3	PR2	PR1	PR0	X	X	X	X	REF	ANL	DAC	ADC	N/A

Note: The ready bits are read only, writing to REF, ANL, DAC, ADC will have no effect. These bits indicate the status for the AD1881 subsections. If the bit is a one, then that subsection is "ready." Ready is defined as the subsection able to perform in its nominal state.

ADC ADC section ready to transmit data.

DAC DAC section ready to accept data.

ANL Analog gainuators, attenuators, and mixers ready.

REF Voltage References, VREF and VREFOUT up to nominal level.

PR[5:0] AD1881 Power-Down Modes. The first three bits are to be used individually rather than in combination with each other. The last bit PR3 can be used in combination with PR2 or by itself. The mixer and reference cannot be powered down via PR3 unless the ADCs and DACs are also powered down. Nothing else can be powered up until the reference is up.

PR5 has no effect unless all ADCs, DACs, and the AC-Link are powered down. The reference and the mixer can be either up or down, but all power-up sequences must be allowed to run to completion before PR5 and PR4 are both set.

In multiple-codec systems, the master codec's PR5 and PR4 bits control the slave codec. PR5 is also effective in the slave codec if the master's PR5 bit is clear, but the PR4 bit has no effect except to enable or disable PR5.

EAPD External Audio Amp Power Down. Available when programmed as an AC '97 codec.

0 = Pin 47 set to LO state (default).

1 = Pin 47 set to HI state.

Power-Down State	PR5	PR4	PR3	PR2	PR1	PR0
ADC Power-Down	0	0	0	0	0	1
DAC Power-Down	0	0	0	0	1	0
ADC and DAC Power-Down	0	0	0	0	1	1
Mixer Power-Down	0	0	0	1	0	0
ADC + Mixer Power-Down	0	0	0	1	0	1
DAC + Mixer Power-Down	0	0	0	1	1	0
ADC + DAC + Mixer Power-Down	0	0	0	1	1	1
Standby	1	1	1	1	1	1

**Extended Audio ID Register (Index 28h)**

Reg Num	Name	D15	D14	D13	D12	D11	D10	D9	D8	D7	D6	D5	D4	D3	D2	D1	D0	Default
28h	Extended Audio ID	ID1	ID0	X	X	X	X	X	X	X	X	X	X	X	X	X	VRA	N/A

Note: The Extended Audio ID is a read only register.

VRA Variable Rate Audio. VRA = 1 enables Variable Rate Audio.

ID[1:0] ID1, ID0 is a 2-bit field that indicates the codec configuration: Primary is 00; Secondary is 01, 10, or 11.

# AD1881

## Extended Audio Status and Control Register (Index 2Ah)

Reg Num	Name	D15	D14	D13	D12	D11	D10	D9	D8	D7	D6	D5	D4	D3	D2	D1	D0	Default
2Ah	Extended Audio St/Ctrl	X	X	X	X	X	X	X	X	X	X	X	X	X	X	X	VRA	na

Note: The Extended Audio Status and Control Register is a read/write register that provides status and control of the extended audio features.

VRA Variable Rate Audio. VRA = 1 enables Variable Rate Audio mode (sample rate control registers and SLOTREQ signaling).

## PCM DAC Rate Register (Index 2Ch)

Reg Num	Name	D15	D14	D13	D12	D11	D10	D9	D8	D7	D6	D5	D4	D3	D2	D1	D0	Default
2Ch/7Ah	PCM DAC Rate	SR15	SR14	SR13	SR12	SR11	SR10	SR9	SR8	SR7	SR6	SR5	SR4	SR3	SR2	SR1	SR0	BB80h

Note: 2Ch is an alias for 7Ah. The VRA bit in register 2Ah must be set for the alias to work; if a zero is written to VRA, both sample rates are reset to 48k.

SR[15:0] Writing to this register allows programming of the sampling frequency from 7 kHz (1B58h) to 48 kHz (BB80h) in 1 Hz increments. Programming a value outside of the range 7040 Hz (1b80h) to 48000 Hz (bb80h) causes the codec to saturate to 48 kHz if a rate greater than 48 kHz is programmed or to 7 kHz if a rate less than 7 kHz is programmed. For all rates, if the value written to the register is supported, that value will be echoed back when read, otherwise the closest rate supported is returned.

## PCM ADC Rate Register (Index 32h)

Reg Num	Name	D15	D14	D13	D12	D11	D10	D9	D8	D7	D6	D5	D4	D3	D2	D1	D0	Default
32h/78h	PCM ADC Rate	SR15	SR14	SR13	SR12	SR11	SR10	SR9	SR8	SR7	SR6	SR5	SR4	SR3	SR2	SR1	SR0	BB80h

Note: 32h is an alias for 78h. The VRA bit in register 2Ah must be set for the alias to work; if a zero is written to VRA, both sample rates are reset to 48k.

SR[15:0] Writing to this register allows programming of the sampling frequency from 7 kHz (1B58h) to 48 kHz (BB80h) in 1 Hz increments. Programming a value outside of the range 7040 Hz (1b80h) to 48000 Hz (bb80h) causes the codec to saturate to 48 kHz if a rate greater than 48 kHz is programmed, or to 7 kHz if a rate less than 7 kHz is programmed. For all rates, if the value written to the register is supported, that value will be echoed back when read, otherwise the closest rate supported is returned.

## Serial Configuration (Index 74h)

Reg Num	Name	D15	D14	D13	D12	D11	D10	D9	D8	D7	D6	D5	D4	D3	D2	D1	D0	Default
74h	Serial Configuration	SLOT16	REGM2	REGM1	REGM0	DRQEN	DLRQ2	DLRQ1	DLRQ0	X	X	X	X	X	DRRQ2	DRRQ1	DRRQ0	X

Note: This register is not reset when the reset register (register 00h) is written.

- DRRQ0 Master Codec DAC right request.
- DRRQ1 Slave 1 Codec DAC right request.
- DRRQ2 Slave 2 Codec DAC right request.
- DLRQ0 Master Codec DAC left request.
- DLRQ1 Slave 1 Codec DAC left request.
- DLRQ2 Slave 2 Codec DAC left request.
- DRQEN Enable DAC request bits in status address and data slot.
- REGM0 Master Codec register mask.
- REGM1 Slave 1 Codec register mask.
- REGM2 Slave 2 Codec register mask.
- SLOT16 Enable 16-bit slots.

**AD1881**

DRQEN and DxRQx are retained only for compatibility with the AD1819. New controller designs should use the VRA bit in register 2Ah and the request bits in the status address slot instead.

If your system uses only a single AD1881, you can ignore the register mask and the slave 1/slave 2 request bits. If you write to this register, write ones to all of the register mask bits. The DxRQx bits are read-only.

The Codec asserts the DxRQx bit when the corresponding DAC channel can accept data in the next frame. These bits are snapshots of the Codec state taken when the current frame began (effectively, on the rising edge of SYNC), but they also take notice of DAC samples sent in the current frame.

If you set the DRQEN bit, the AD1881 will fill all; otherwise, unused AC Link status address and data slots with the contents of register 74h. That makes it somewhat simpler to access the information because you don't need to continually issue AC Link read commands to obtain the register contents.

Also, the DAC requests are reflected in Slot 1, bits (11 . . . 6).

SLOT16 makes all AC Link slots 16 bits in length, formatted into 16 slots.

**Miscellaneous Control Bits (Index 76h)**

Reg Num	Name	D15	D14	D13	D12	D11	D10	D9	D8	D7	D6	D5	D4	D3	D2	D1	D0	Default
76h	Misc Control Bits	DAC Z	LPMIX X	DAM X	DMS	DLSR X	X	ALSR	MOD EN	SRX10 D7	SRX8 D7	X	X	DRSR	X	ARSR	0000h	

- ARSR ADC right sample generator select.  
0 = SR0 Selected (32h)  
1 = SR1 Selected (2Ch).
- DRSR DAC right sample generator select.  
0 = SR0 Selected (32h)  
1 = SR1 Selected (2Ch).
- SRX8D7 Multiply SR1 rate by 8/7.
- SRX10D7 Multiply SR1 rate by 10/7. SRX10D7 and SRX8D7 are mutually exclusive; SRX10D7 has priority if both are set.
- MODEN Modem filter enable (left channel only). Change only when DACs are powered down.
- ALSR ADC left sample generator select.  
0 = SR0 Selected (32h)  
1 = SR1 Selected (2Ch).
- DLSR DAC left sample generator select.  
0 = SR0 Selected (32h)  
1 = SR1 Selected (2Ch).
- DMS Digital Mono Select.  
0 = Mixer  
1 = Left DAC and Right DAC.
- DAM Digital Audio Mode. DAC Outputs bypass analog mixer and sent directly to the codec output.
- LPMIX Low Power Mixer. Keeps CD to LINE\_OUT alive for notebook applications.
- DACZ Zero fill (vs. repeat) if DAC is starved for data.

**Sample Rate 0 (Index 78h)**

Reg Num	Name	D15	D14	D13	D12	D11	D10	D9	D8	D7	D6	D5	D4	D3	D2	D1	D0	Default
78h	Sample Rate 0	SR015	SR014	SR013	SR012	SR011	SR010	SR09	SR08	SR07	SR06	SR05	SR04	SR03	SR02	SR01	SR00	BB80H

Note: 32h is an alias for 78h. The VRA bit in register 2Ah must be set for the alias to work; if a zero is written to VRA then both sample rates are reset to 48k.

SR0[15:0] Writing to this register allows the user to program the sampling frequency from 7 kHz (1B58h) to 48 kHz (BB80h) in 1 Hertz increments. Programming a value greater than 48 kHz or less than 7 kHz may cause unpredictable results.

# AD1881

## Sample Rate 1 (Index 7Ah)

Reg Num	Name	D15	D14	D13	D12	D11	D10	D9	D8	D7	D6	D5	D4	D3	D2	D1	D0	Default
7Ah	Sample Rate 1	SR115	SR114	SR113	SR112	SR111	SR110	SR19	SR18	SR17	SR16	SR15	SR14	SR13	SR12	SR11	SR10	BB80h

Note: 2Ch is an alias for 7Ah. The VRA bit in register 2Ah must be set for the alias to work; if a zero is written to VRA, both sample rates are reset to 48k.

SR1[15:0] Writing to this register allows the user to program the sampling frequency from 7 kHz (1B58h) to 48 kHz (BB80h) in 1 Hertz increments. Programming a value greater than 48 kHz or less than 7 kHz may cause unpredictable results.

## Vendor ID Registers (Index 7Ch-7Eh)

Reg Num	Name	D15	D14	D13	D12	D11	D10	D9	D8	D7	D6	D5	D4	D3	D2	D1	D0	Default
7Ch	Vendor ID1	F7	F6	F5	F4	F3	F2	F1	F0	S7	S6	S5	S4	S3	S2	S1	S0	4144h

S[7:0] This register is ASCII encoded to "A."

F[7:0] This register is ASCII encoded to "D."

Reg Num	Name	D15	D14	D13	D12	D11	D10	D9	D8	D7	D6	D5	D4	D3	D2	D1	D0	Default
7Eh	Vendor ID2	T7	T6	T5	T4	T3	T2	T1	T0	REV7	REV6	REV5	REV4	REV3	REV2	REV1	REV0	53XXh

T[7:0] This register is ASCII encoded to "S."

REV[7:0] Revision Register field contains the revision number.

These bits are read-only and should be verified before accessing vendor defined features.

## AD1819/AD1819A/AD1881 USER-VISIBLE DIFFERENCES

- Supports 3.3 V digital VDD (as well as 5 V).

### Register Differences

- Reserved register bits always yield zero when read.
- Writes to odd registers have no effect, instead of writing preceding even register. Reads of odd registers always return zero instead of value of preceding even register.
- Writing ones to bits 5 or 13 of register 02h no longer forces bits 4:0 or 12:8 to ones.
- Registers 04h and 08h are now reserved.
- It is no longer required that the mixer not be powered down in order to power up the DACs, and the mixer can be powered down without also powering down the DACs.
- Aliases 2Ch (7Ah) and 32h (78h) have been added with AC '97 2.0 behavior.
- Registers 28h and 2Ah have been added; writing a zero to the LSB of register 2Ah resets registers 2Ch (7Ah) and 32h (78h).
- Register 76h default value is 0404h instead of 0000h; DAM, DMS and LPMIX bits have been added.
- LSB of register 7Eh is 40h instead of 00h-03h.

### Analog Differences

- CD to LINE\_OUT path noninverting instead of inverting.
- Mixer feed through when powered off eliminated.

# AD1881

## APPLICATIONS CIRCUITS

The AD1881 has been designed to require a minimum amount of external circuitry. The recommended applications circuits are shown in Figures 9 and 10. Reference designs for the AD1881 are available and may be obtained by contacting your local Analog Devices' sales representative or authorized distributor. Example shell programs for establishing a communications path between the AD1881 and an ADSP-21xx are also available.

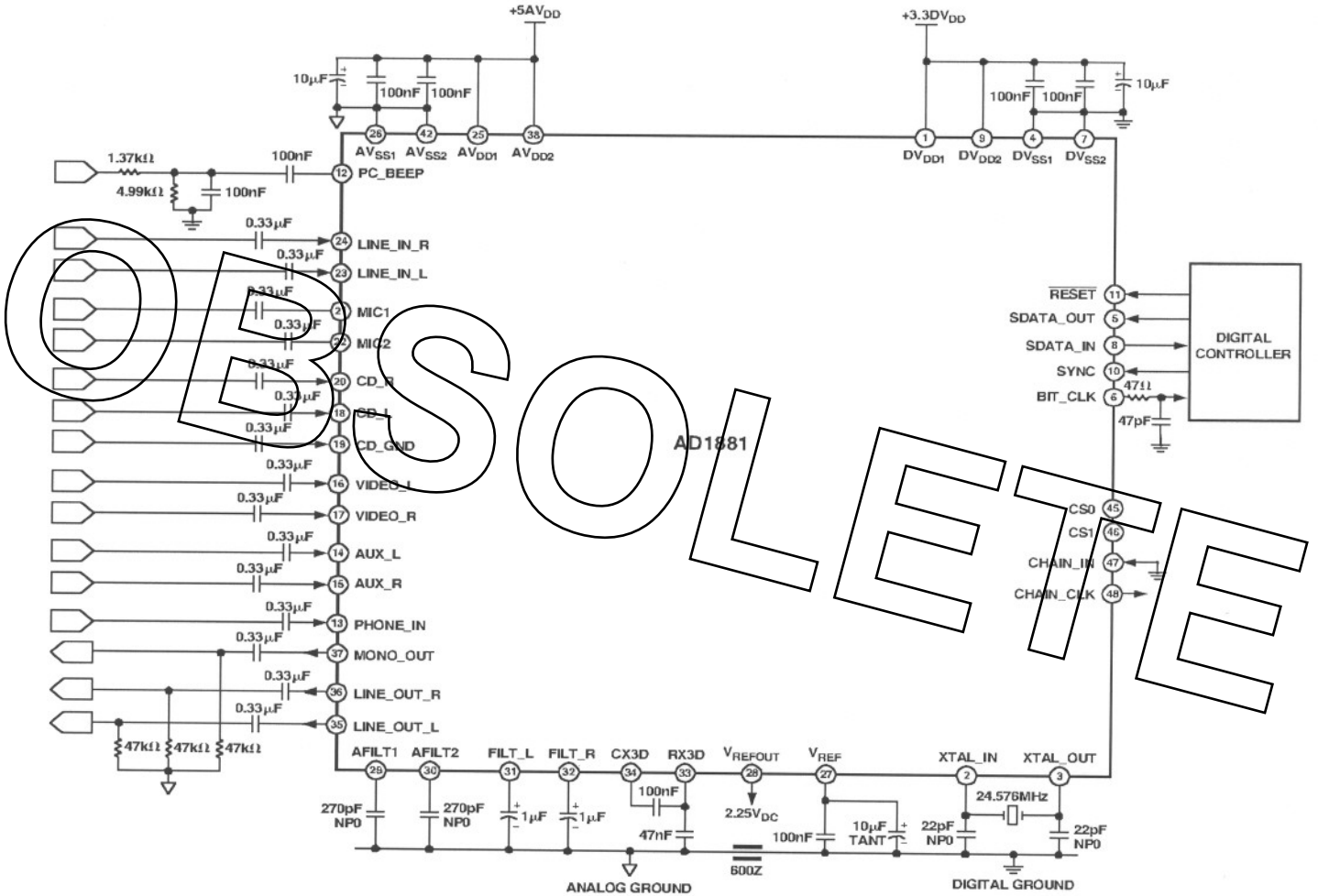

Figure 9. Recommended One Codec Application Circuit

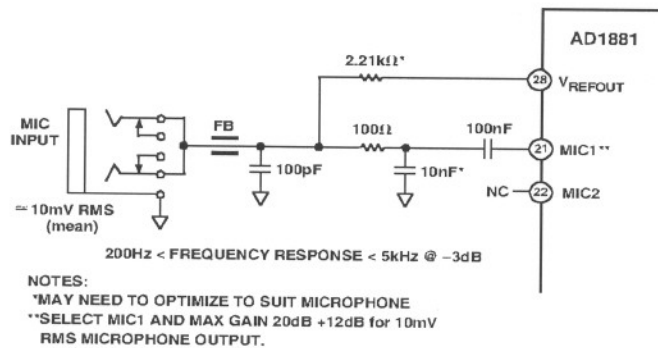

Figure 10. Microphone Input

# AD1881

## OUTLINE DIMENSIONS

Dimensions shown in inches and (mm).

### 48-Lead Thin Plastic Quad Flatpack (LQFP) (ST-48)

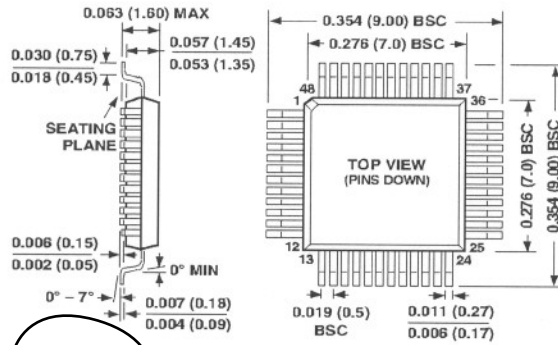

OBSOLETE

C3462-8-5/99

PRINTED IN U.S.A.